

version .0

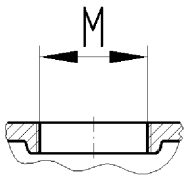

version .1

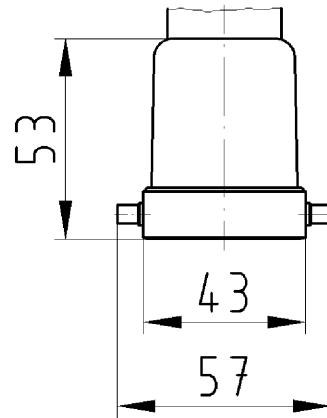
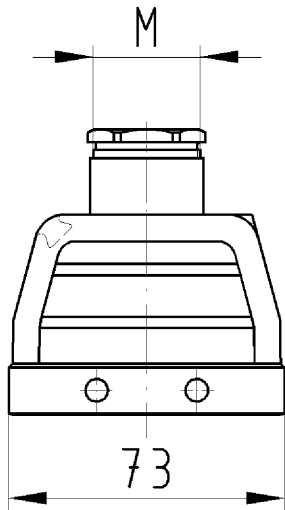
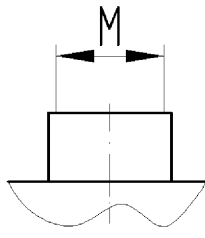

version .2

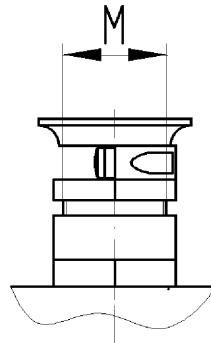

version .3

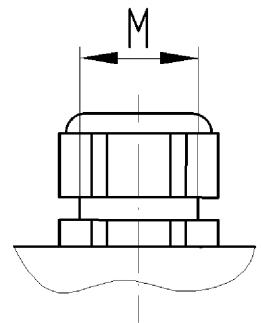

version .5

IP 65

Gehäuseoberenteil
70.352/354.1035.0
72.352/354.1035.0

Zeichnungsnummer
70.352.1035.010W
Gehäuseoberenteil

21.11.2007
Schreiber Patrick
M 1:2